

## COSMOS SQUARE SUSPENSION

### D1010050-

base number      LED Dimming      Color Temperature      Finish Options

- To build a product code in our configurator select the specify button on the base model # product page
- To build a manual product code on this datasheet choose from the options listed below in blue font and add the suffix to the base model #

#### GENERAL

Series: Cosmos Square  
 Brand: Quasar  
 Division: Design  
 Mounting Type: Suspension  
 Mounting Location: Ceiling  
 Subcategory: Ambient

#### PHYSICAL

Shape: Square  
 Length (mm): 1500  
 Length (in): 59 1/16  
 Width (mm): 305  
 Width (in): 12  
 Height (mm): 400  
 Height (in): 15 3/4  
 Max. Overall Height (mm): 2450  
 Max. Overall Height (in): 94 1/2  
 Light Distribution: Omnidirectional  
 Weight (kg): 8  
 Weight (lbs): 17.64  
[Fixture Finish: NIC / BRA / BBR](#)  
 Fixture Material: Metal  
 Cable Details: 2000mm Cable  
 Upon Request: Custom Sizes Optional Dowlight upon request

#### ELECTRICAL

Number of Lamps: 135  
 Lamp Type: LED  
 Input Wattage (W): 81  
 Bulb Included: Bulb Included  
 Max. Wattage Per Lamp (W): 0.6  
[Dimming: Tri-Mode \(Non-Dimming and Phase Dimming \(120Vac only\) and 0-10V Dimming\)](#)  
 Driver Included: Yes  
 Driver Location: Integrated  
 Driver Type: Constant Voltage - Universal  
 Driver Class: Class 2  
 Input Voltage (V): 120 - 277  
 Output Voltage (V): 12

#### LED

Number of LEDs: 135  
[Color Temperature \(°K\): 2400 / 2800](#)  
 Max. Delivered Lumen (lm): 4050 (2800K)  
 CRI: >90 CRI  
 Lamp Life (hrs): 50000

#### OPTICAL

#### RATINGS AND CERTIFICATIONS

Certified By: Certified for North American Standards  
 IP rating: IP20

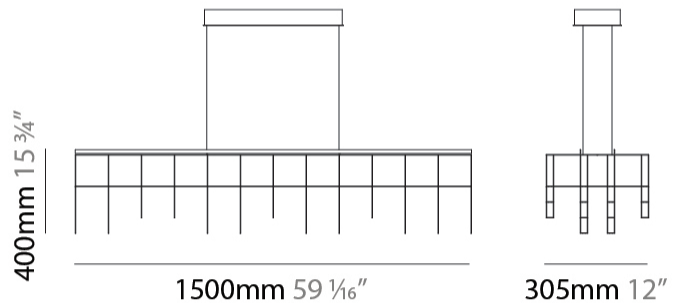

## COSMOS SQUARE SUSPENSION

D1010050-

PROJECT \_\_\_\_\_

TYPE \_\_\_\_\_

SPECIFIER \_\_\_\_\_

QUANTITY \_\_\_\_\_

DATE \_\_\_\_\_

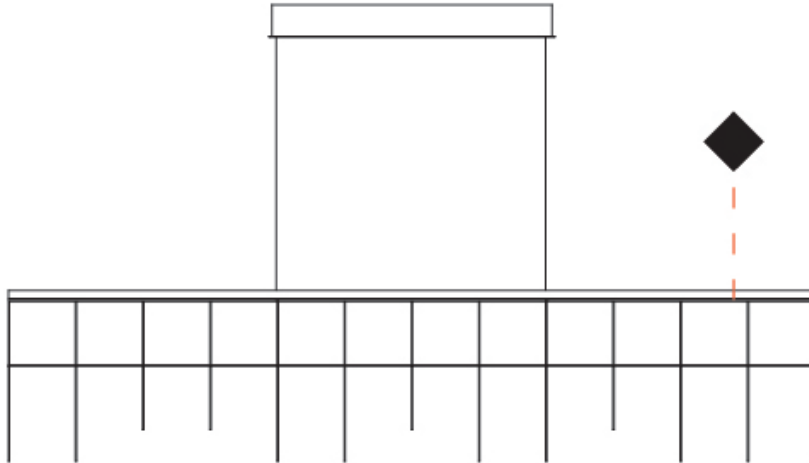

## COSMOS SQUARE SUSPENSION

### D1010051-

base number      LED Dimming      Color Temperature      Finish Options

- To build a product code in our configurator select the specify button on the base model # product page
- To build a manual product code on this datasheet choose from the options listed below in blue font and add the suffix to the base model #

#### GENERAL

Series: Cosmos Square  
 Brand: Quasar  
 Division: Design  
 Mounting Type: Suspension  
 Mounting Location: Ceiling  
 Subcategory: Ambient

#### PHYSICAL

Shape: Square  
 Length (mm): 3000  
 Length (in): 118 1/8  
 Width (mm): 305  
 Width (in): 12  
 Height (mm): 400  
 Height (in): 15 3/4  
 Max. Overall Height (mm): 2450  
 Max. Overall Height (in): 94 1/2  
 Light Distribution: Omnidirectional  
 Weight (kg): 16  
 Weight (lbs): 35.27  
[Fixture Finish: NIC / BRA / BBR](#)  
 Fixture Material: Metal  
 Cable Details: 2000mm Cable  
 Upon Request: Custom Sizes Optional Dowlight upon request

#### ELECTRICAL

Number of Lamps: 258  
 Lamp Type: LED  
 Input Wattage (W): 155  
 Max. Wattage Per Lamp (W): 0.6  
[Dimming: 0-10V Dimming / Phase Dimming \(120Vac Only\)](#)  
 Driver Included: Yes  
 Driver Location: Integrated  
 Driver Type: Constant Voltage - Universal  
 Driver Class: Class 1  
 Input Voltage (V): 120 - 277  
 Output Voltage (V): 12

#### LED

Number of LEDs: 258  
[Color Temperature \(°K\): 2400 / 2800](#)  
 Max. Delivered Lumen (lm): 7740 (2800K)  
 CRI: >90 CRI  
 Lamp Life (hrs): 50000

#### OPTICAL

#### RATINGS AND CERTIFICATIONS

Certified By: Certified for North American Standards  
 IP rating: IP20

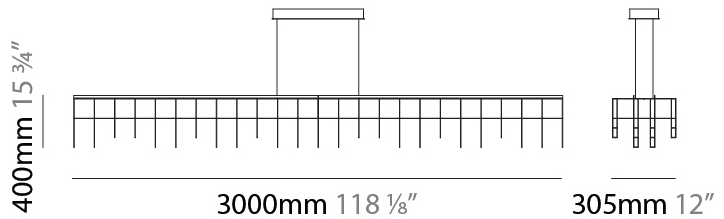

## COSMOS SQUARE SUSPENSION

D1010051-

PROJECT \_\_\_\_\_

TYPE \_\_\_\_\_

SPECIFIER \_\_\_\_\_

QUANTITY \_\_\_\_\_

DATE \_\_\_\_\_

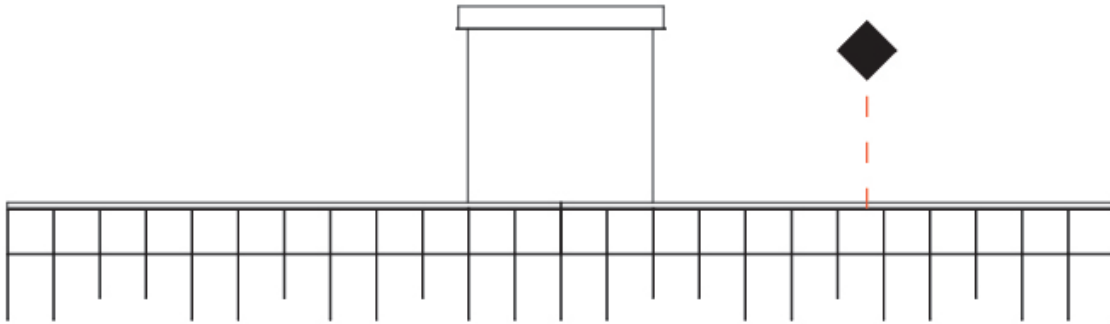

## COSMOS SQUARE SUSPENSION

### D101741-

base number    LED Dimming    Color Temperature    Finish Options

PROJECT
TYPE
SPECIFIER
QUANTITY
DATE

- To build a product code in our configurator select the specify button on the base model # product page
- To build a manual product code on this datasheet choose from the options listed below in blue font and add the suffix to the base model #

#### GENERAL

Series: Cosmos Square  
 Brand: Quasar  
 Division: Design  
 Mounting Type: Suspension  
 Mounting Location: Ceiling  
 Subcategory: Ambient

#### PHYSICAL

Shape: Rectangle  
 Length (mm): 875  
 Length (in): 34 7/16  
 Width (mm): 395  
 Width (in): 15 9/16  
 Height (mm): 250  
 Height (in): 9 13/16  
 Max. Overall Height (mm): 2250  
 Max. Overall Height (in): 88 9/16  
 Light Distribution: Omnidirectional  
 Weight (kg): 4  
 Weight (lbs): 8.82  
[Fixture Finish: NIC / BRA / BBR](#)  
 Fixture Material: Metal  
 Cable Details: 2000mm Cable  
 Upon Request: Custom Sizes Optional Dowlight upon request

#### ELECTRICAL

Lamp Type: LED  
 Input Wattage (W): 57.6  
[Dimming: Non-Dimming / Phase Dimming \(120vac Only\)](#)  
 Driver Included: Yes  
 Driver Location: Integrated  
 Driver Type: Constant Voltage - Universal  
 Driver Class: Class 2  
 Input Voltage (V): 120 - 277  
 Output Voltage (V): 12  
 Upon Request: (Not included - see components) Integral: 0-10Vdc dimming

#### LED

Number of LEDs: 96  
[Color Temperature \(°K\): 2400 / 2800](#)  
 Max. Delivered Lumen (lm): 2880 (2800K)  
 CRI: >90 CRI  
 Lamp Life (hrs): 50000

#### OPTICAL

#### RATINGS AND CERTIFICATIONS

Certified By: Certified for North American Standards  
 IP rating: IP20

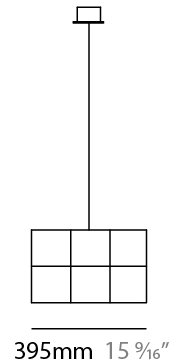
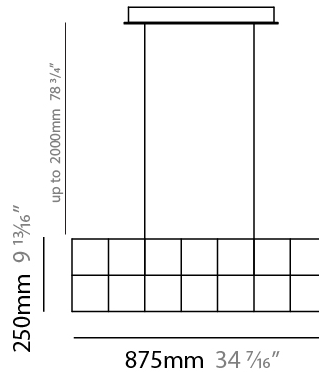
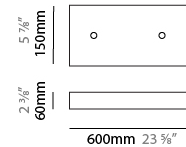
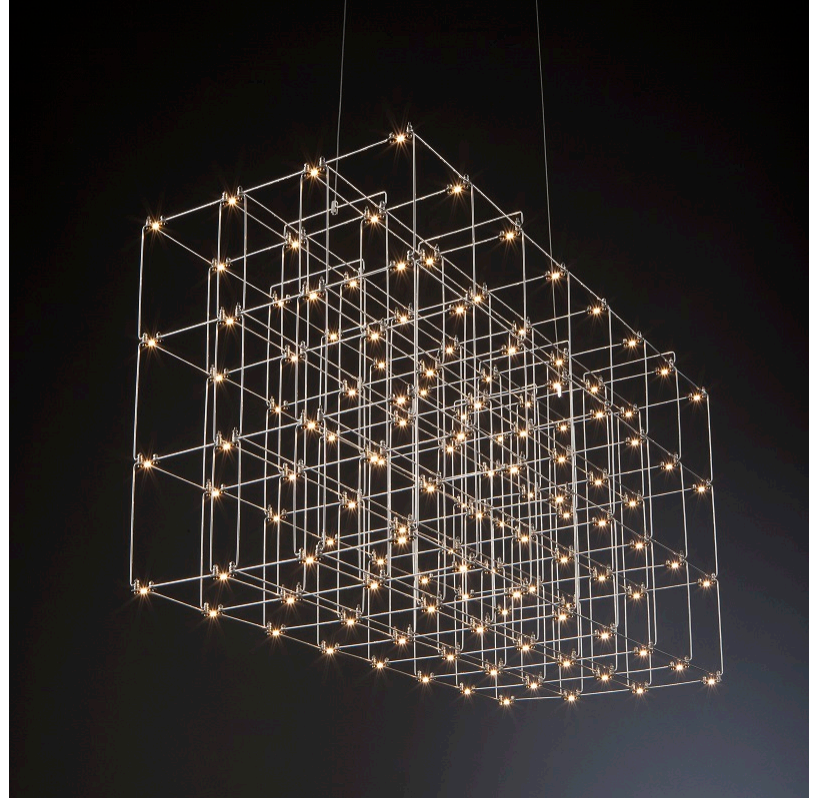

## COSMOS SQUARE SUSPENSION

D101741-

PROJECT \_\_\_\_\_

TYPE \_\_\_\_\_

SPECIFIER \_\_\_\_\_

QUANTITY \_\_\_\_\_

DATE \_\_\_\_\_

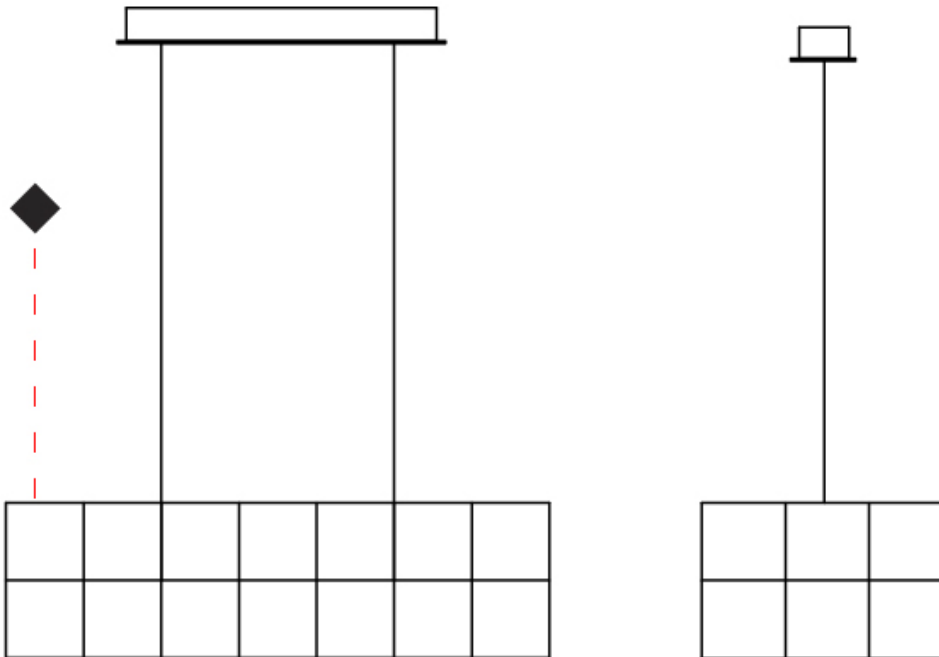

## COSMOS SQUARE SUSPENSION

### D101742-

base number    LED Dimming    Color Temperature    Finish Options

PROJECT \_\_\_\_\_

TYPE \_\_\_\_\_

SPECIFIER \_\_\_\_\_

QUANTITY \_\_\_\_\_

DATE \_\_\_\_\_

- To build a product code in our configurator select the specify button on the base model # product page
- To build a manual product code on this datasheet choose from the options listed below in blue font and add the suffix to the base model #

#### GENERAL

Series: Cosmos Square

Brand: Quasar

Division: Design

Mounting Type: Suspension

Mounting Location: Ceiling

Subcategory: Ambient

#### PHYSICAL

Shape: Rectangle

Length (mm): 875

Length (in): 34 <sup>7</sup>/<sub>16</sub>

Width (mm): 395

Width (in): 15 <sup>9</sup>/<sub>16</sub>

Height (mm): 375

Height (in): 14 <sup>3</sup>/<sub>4</sub>

Max. Overall Height (mm): 2375

Max. Overall Height (in): 93 <sup>1</sup>/<sub>2</sub>

Light Distribution: Omnidirectional

Weight (kg): 4.5

Weight (lbs): 9.92

Fixture Finish: [NIC / BRA / BBR](#)

Fixture Material: Metal

Cable Details: 2000mm Cable

Upon Request: Custom Sizes Optional Dowlight upon request

#### ELECTRICAL

Lamp Type: LED

Input Wattage (W): 76.8

Dimming: [Non-Dimming / Phase Dimming \(120vac Only\)](#)

Driver Included: Yes

Driver Location: Integrated

Driver Type: Constant Voltage - Universal

Driver Class: Class 2

Input Voltage (V): 120 - 277

Output Voltage (V): 12

Upon Request: (Not included - see components) Integral: 0-10Vdc dimming

#### LED

Number of LEDs: 128

Color Temperature (°K): [2400 / 2800](#)

Max. Delivered Lumen (lm): 3840 (2800K)

CRI: >90 CRI

Lamp Life (hrs): 50000

#### OPTICAL

#### RATINGS AND CERTIFICATIONS

Certified By: Certified for North American Standards

IP rating: IP20

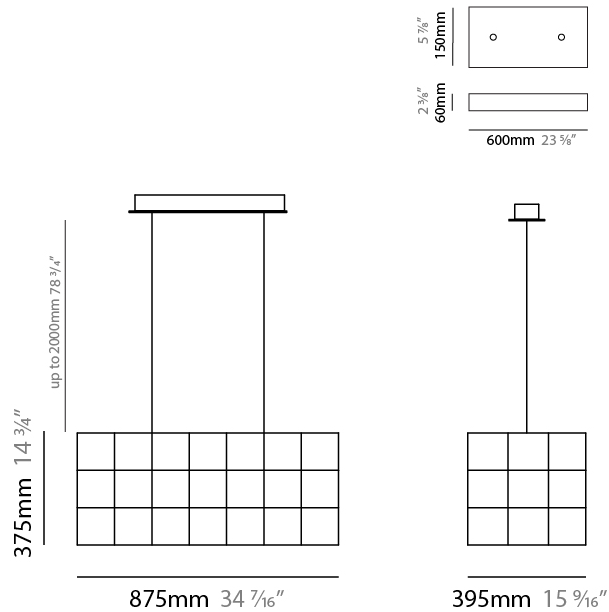
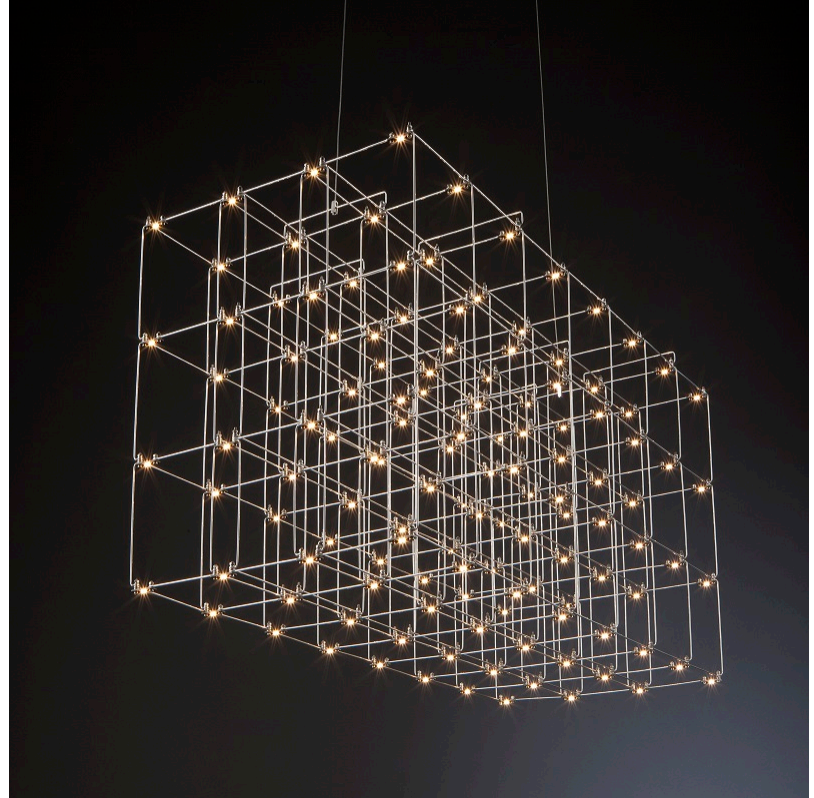

## COSMOS SQUARE SUSPENSION

D101742-

PROJECT \_\_\_\_\_

TYPE \_\_\_\_\_

SPECIFIER \_\_\_\_\_

QUANTITY \_\_\_\_\_

DATE \_\_\_\_\_

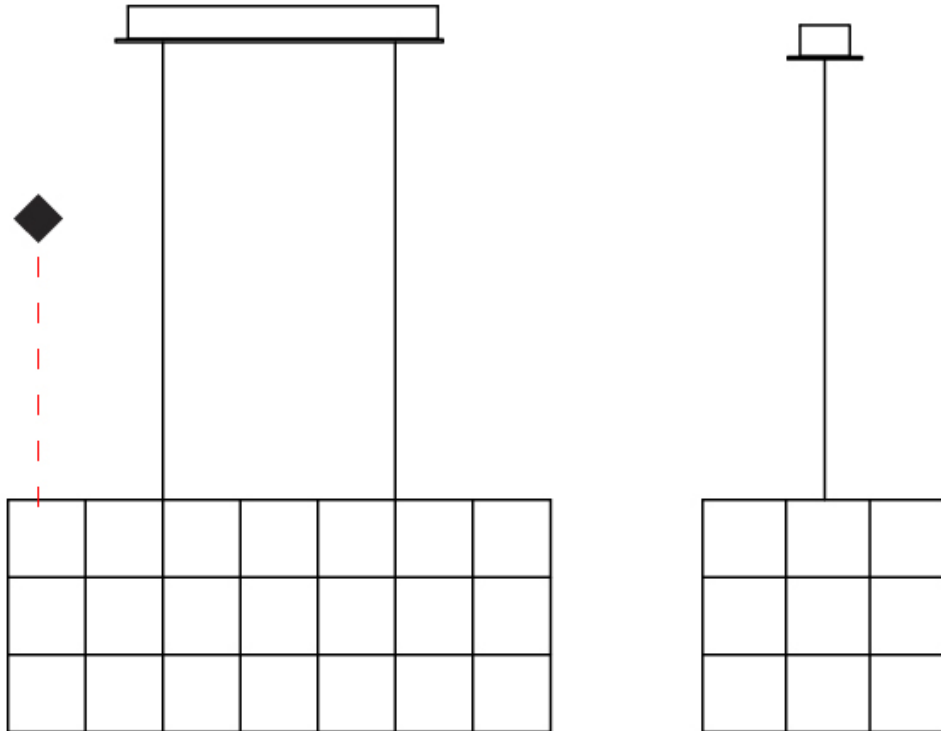



## COSMOS SQUARE SUSPENSION

### D101743-

base number    LED    Color    Finish  
 Dimming    Temperature    Options

- To build a product code in our configurator select the specify button on the base model # product page
- To build a manual product code on this datasheet choose from the options listed below in blue font and add the suffix to the base model #

#### GENERAL

Series: Cosmos Square  
 Brand: Quasar  
 Division: Design  
 Mounting Type: Suspension  
 Mounting Location: Ceiling  
 Subcategory: Ambient

#### PHYSICAL

Shape: Square  
 Length (mm): 1000  
 Length (in): 39 3/8"  
 Width (mm): 1000  
 Width (in): 39 3/8"  
 Height (mm): 850  
 Height (in): 33 7/16"  
 Max. Overall Height (mm): 2850  
 Max. Overall Height (in): 112 3/16"  
 Light Distribution: Omnidirectional  
 Weight (kg): 24  
 Weight (lbs): 52.91  
[Fixture Finish: NIC / BRA / BBR](#)  
 Fixture Material: Metal  
 Cable Details: 2000mm Cable  
 Upon Request: Custom Sizes Optional Dowlight upon request

#### ELECTRICAL

Lamp Type: LED  
 Input Wattage (W): 328.8  
[Dimming: Non-Dimming / Phase Dimming \(120vac Only\)](#)  
 Driver Included: Yes  
 Driver Location: Integrated  
 Driver Type: Constant Voltage - Universal  
 Driver Class: Class 2  
 Input Voltage (V): 120 - 277  
 Output Voltage (V): 12

#### LED

Number of LEDs: 548  
[Color Temperature \(°K\): 2400 / 2800](#)  
 Max. Delivered Lumen (lm): 16440 (2800K)  
 CRI: >90 CRI  
 Lamp Life (hrs): 50000

#### OPTICAL

#### RATINGS AND CERTIFICATIONS

Certified By: Certified for North American Standards  
 IP rating: IP20

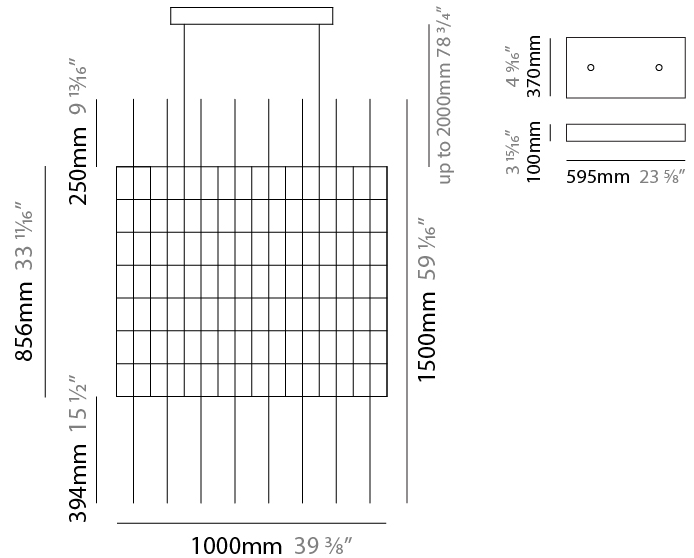
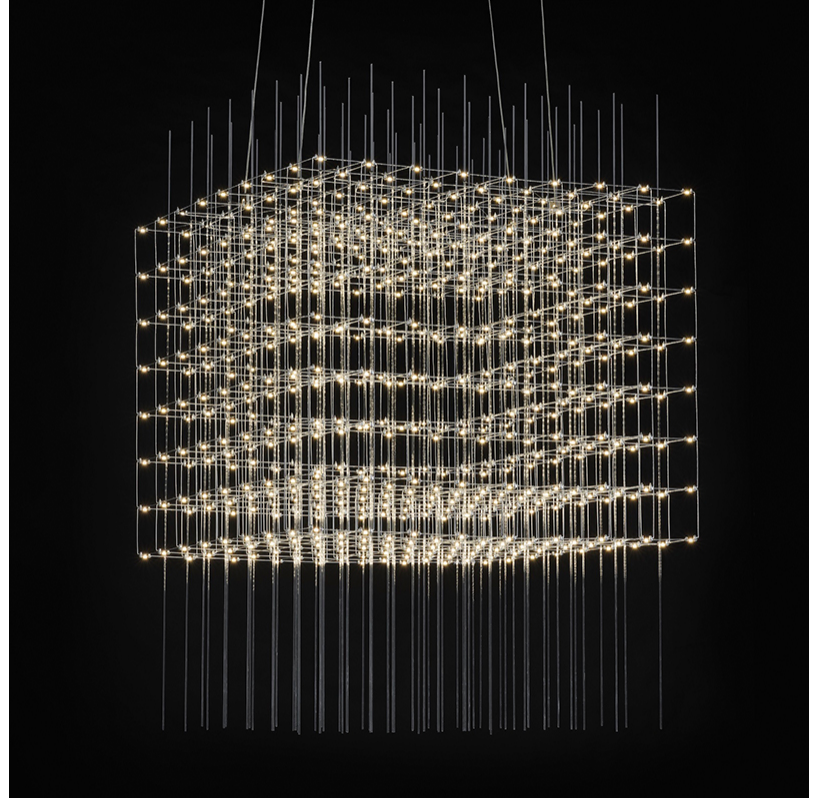

## COSMOS SQUARE SUSPENSION

D101743-

PROJECT

TYPE

SPECIFIER

QUANTITY

DATE

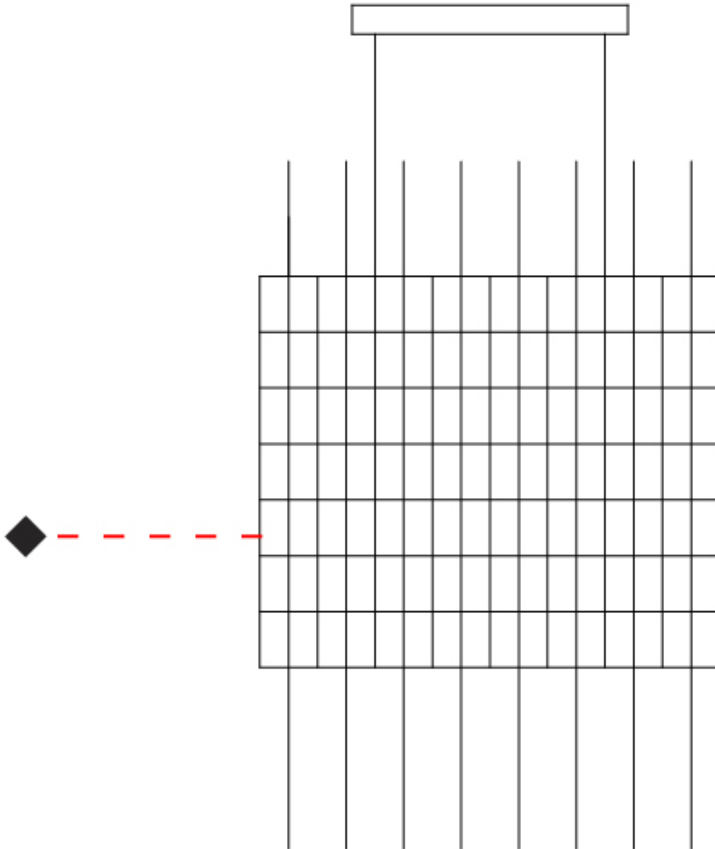

D

## COSMOS SQUARE SUSPENSION

### D101944-

base number    LED    Color    Finish  
 Dimming    Temperature    Options

- To build a product code in our configurator select the specify button on the base model # product page
- To build a manual product code on this datasheet choose from the options listed below in blue font and add the suffix to the base model #

#### GENERAL

Series: Cosmos Square  
 Brand: Quasar  
 Division: Design  
 Mounting Type: Suspension  
 Mounting Location: Ceiling  
 Subcategory: Ambient

#### PHYSICAL

Shape: Square  
 Length (mm): 1000  
 Length (in): 39 <sup>3</sup>/<sub>8</sub>"  
 Width (mm): 1000  
 Width (in): 39 <sup>3</sup>/<sub>8</sub>"  
 Height (mm): 850  
 Height (in): 33 <sup>7</sup>/<sub>16</sub>"  
 Max. Overall Height (mm): 2850  
 Max. Overall Height (in): 112 <sup>3</sup>/<sub>16</sub>"  
 Light Distribution: Omnidirectional  
 Weight (kg): 24  
 Weight (lbs): 52.91  
[Fixture Finish: NIC / BRA / BBR](#)  
 Fixture Material: Metal  
 Cable Details: 2000mm Cable  
 Upon Request: Custom Sizes Optional Dowlight upon request

#### ELECTRICAL

Lamp Type: LED  
 Input Wattage (W): 328.8  
[Dimming: 0-10V Dimming / Phase Dimming \(120Vac Only\)](#)  
 Driver Included: Yes  
 Driver Location: Integrated  
 Driver Type: Constant Voltage - Universal  
 Driver Class: Class 2  
 Input Voltage (V): 120 - 277  
 Output Voltage (V): 12

#### LED

Number of LEDs: 548  
[Color Temperature \(°K\): 2400 / 2800](#)  
 Max. Delivered Lumen (lm): 16440 (2800K)  
 CRI: >90 CRI  
 Lamp Life (hrs): 50000

#### OPTICAL

#### RATINGS AND CERTIFICATIONS

Certified By: Certified for North American Standards  
 IP rating: IP20

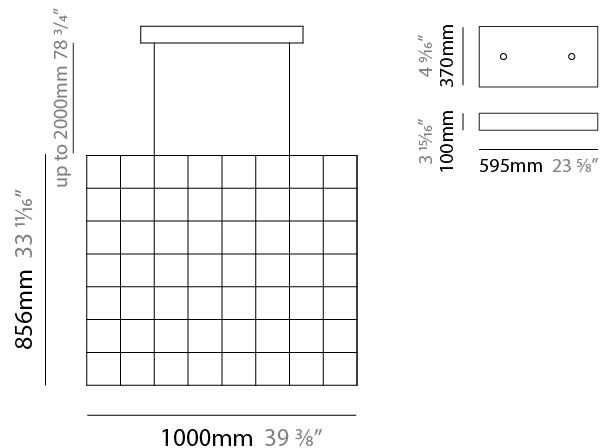
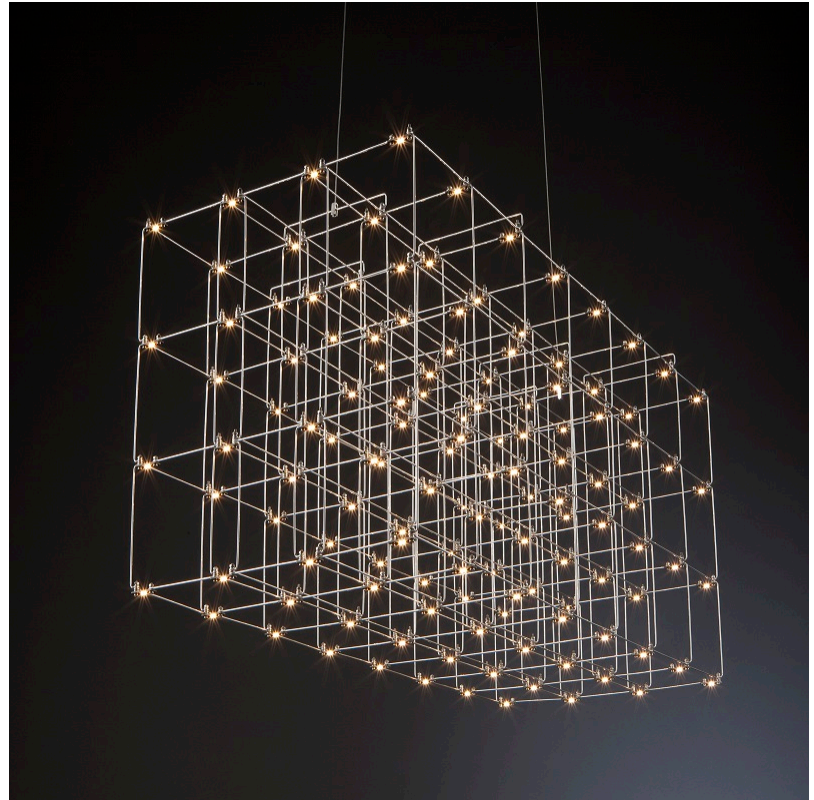

## COSMOS SQUARE SUSPENSION

D101944-

PROJECT

TYPE

SPECIFIER

QUANTITY

DATE

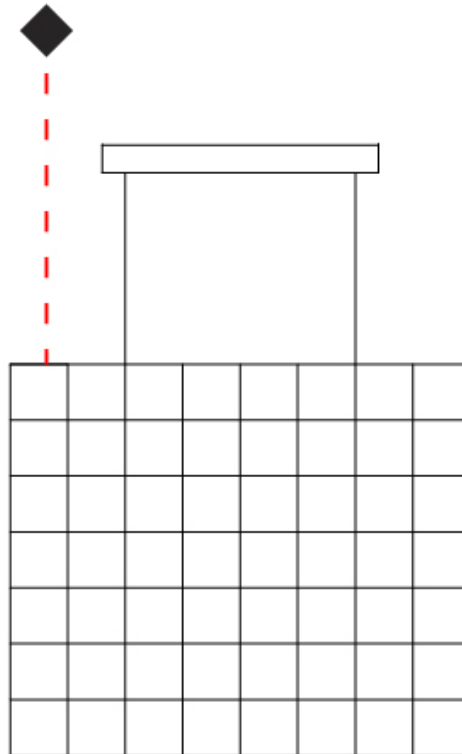

PROJECT \_\_\_\_\_

TYPE \_\_\_\_\_

SPECIFIER \_\_\_\_\_

QUANTITY \_\_\_\_\_

DATE \_\_\_\_\_

### Fixture Finish

Nickel - NIC



Brass - BRA



Black Brass - BBR

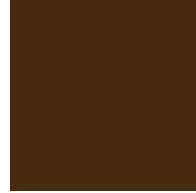

**Digital:** Not all screens are calibrated the same, and therefore, colors will appear differently between screens.

**Physical:** When texture is involved, there will be variations in color, character and tone within a product series and between product families.

Brass, nickel and copper are natural minerals and can potentially change color and show marks over time. We cannot guarantee the color appearance as the material transforms.



PROJECT	
TYPE	
SPECIFIER	
QUANTITY	
DATE	

### LEGEND

floor-mounted	pivotal	special LED (upon request) RGB, RGBW, tunable, gold+, meat+, art+, fashion+
wall and ceiling: recessed and surface mounted	rotating	warm dim / natural dimming LED
ceiling-mounted and wall-mounted	illuminate tilted	rechargeable battery powered
wall-mounted	color of suspension cable	fixture with natural vivid LED (upon request)
omni-directional light distribution	length of suspension cable	color rendering index
direct light distribution	reflector degree selection	color temperature
direct/indirect light distribution	super spot	lumen (luminous flux)
indirect light distribution	lens	efficacy (lumens per watt)
asymmetric light distribution	lens pack	Unified Glare Rating (UGR) range from 5-40
aura light distribution	shine ring	marine grade (AISI 316 stainless steel)
round wall or ceiling cut-out	integrated shine ring with diffuser	walk on
square wall or ceiling cut-out	free individual colors 01-29	drive on
the supplied jig specifies the cutout dimensions	individual colors: 00 (free of charge), 01-25 (extra charge)	Dark Sky Compliance
minimum distance (meters) lamp - object	luminaire part to be colored (F1)	Americans with Disabilities Act (less than 4" off the wall located between 27"-84" from floor)
recessed depth	luminaire part to be colored (F2)	lamp protected against explosion
ceiling thickness in mm	luminaire part to be colored (F3)	blown glass using traditional methods by master glass blower
ceiling thickness selection	luminaire part to be colored (F4)	acoustic material
dimmable DP (phase), DV (0-10V), DD (dali), DS (step-dim)	luminaire part to be colored (F5)	protection class I, protection insulation
included or excluded LED driver/transformer/control gear	color of 3-circuit adaptor	protection class II, protection insulation
separately switchable	indirect diffuser	ETL Certified to UL and CSA Standards
sensor	direct diffuser	UL Certified to UL and CSA Standards
remote control	ball-proof (upon request)	CSA Certified to UL and CSA Standards
available upon request	accessory	Certified for North American Standards

### IP RATING

IP20	protected against ingress of solid bodies greater than 12.5mm (finger)
IP33	protected against ingress of solid bodies greater than 2.5mm protected against sprays of water up to 60 degrees from the vertical (rain)
IP40	protected against ingress of solid bodies greater than 1mm (wire) no protection against the ingress of moisture
IP43	protected against ingress of solid bodies greater than 1mm (wire) protected against sprays of water up to 60 degrees from the vertical (rain)
IP44	protected against ingress of solid bodies greater than 1mm (wire) protected against water splashed from all directions
IP54	protected against limited ingress of dust (wet rooms/covered outdoor areas) protected against water splashed from all directions
IP65	protected against ingress of dust protected against jets of water
IP66	protected against ingress of dust protected against powerful jets of water or heavy seas
IP67	protected against ingress of dust protected against immersion of water between 15cm - 1m for 30 minutes
IP68	protected against ingress of dust protected against immersion of water under pressure for long periods

### IK RATING

IK01	protected against 0.14 joules impact (equivalent to 0.25kg mass dropped from 56mm above the surface)
IK02	protected against 0.2 joules impact (equivalent to 0.25kg mass dropped from 80mm above the surface)
IK03	protected against 0.35 joules impact (equivalent to 0.25kg mass dropped from 140mm above the surface)
IK04	protected against 0.5 joules impact (equivalent to 0.25kg mass dropped from 200mm above the surface)
IK05	protected against 0.7 joules impact (equivalent to 0.25kg mass dropped from 280mm above the surface)
IK06	protected against 1 joules impact (equivalent to 0.25kg mass dropped from 400mm above the surface)
IK07	protected against 2 joules impact (equivalent to 0.5kg mass dropped from 400mm above the surface)
IK08	protected against 5 joules impact (equivalent to 1.7kg mass dropped from 300mm above the surface)
IK09	protected against 10 joules impact (equivalent to 5.0kg mass dropped from 200mm above the surface)
IK10	protected against 20 joules impact (equivalent to 5.0kg mass dropped from 400mm above the surface)